

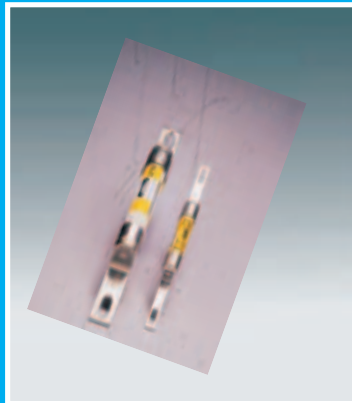

## Low Voltage HBC Fuselinks





**GE Power Controls** type NS/T/TS range of High Breaking Capacity (HBC) fuselinks are extensively used for protection of low voltage circuits. The fuselinks are available in ratings from 2 A to 800 A both in 415V and 660V ac range.

All fuselinks comply with the requirements of IS 13703-1993/ IEC 269-1986 and have breaking capacity of 80kA. All fuselinks are ISI certified.

The widespread use of GE Power Controls HBC fuselinks are based on the following reasons.

### **High breaking capacity and energy limitation**

In the event of a damaging short-circuit, the fault energy is severely restricted by rapid fuselink operation.

### **Restriction of electromagnetic stress**

The fuselinks limit the amount of electromagnetic stress that would otherwise cause severe and costly mechanical damage to current carrying components.

### **Reliability and non-deterioration**

All fuselinks in practice do not need replacing until one has blown. Proven technology and expertise ensure the highest quality, guaranteeing performance, reliability and years of uninterrupted service.

### **Accurate discrimination**

In any well designed electrical installation, HBC fuselinks are the main protective device in both primary and branch circuits. The fuselinks will discriminate with each other much more readily than other protective devices.

### **Reliable short-circuit and back up protection**

The fuselinks are chosen by leading manufacturers of motor starters to provide type 2 co-ordination to IEC 947-4.

### **Low over current protection**

The current and energy limiting properties of HBC fuselinks ensure that the prospective short circuit currents are restricted to levels well within the overload capability of cables. Class 'gG' fuselinks to IS13703/IEC 269 provide close excess current protection enabling cables to be fully rated.

### **Motor circuit capability**

All fuselinks have time/current characteristics which are suitable for motor circuits. They will withstand motor starting surges without deterioration.

### **Cool running**

The fuselinks have 'watts loss' well within limits specified in International Standards.

### **Approval**

Approved by the Bureau of Indian Standards and bear ISI marking as a mark of superior quality.



## Range :

Voltage and current as per table below. All have breaking capacity of 80 kA at the respective voltages indicated.

Type		Rating (A)	
T	TS	Compact range 415V ac	
660V ac	415V ac		
--	--	SS	2, 4, 6, 10, 16, 20
--	--	NS	2, 4, 6, 10, 16, 20, 25, 32
--	--	ES	2, 4, 6, 10, 16, 20, 25, 32, 36, 50, 63
--	--	EIT	2, 4, 6, 10, 16, 20, 25, 32, 36, 50, 63
TIA	TSA	--	6, 10, 16, 20, 25, 32
TIS	TSS	--	36, 50, 63
TCP	TSD	TSDS	80, 100
--	TSD	TSDS	125
TC	TSDC	--	80, 100
TFP	TSFP	--	125, 160, 200
TF	TSF	--	125, 160, 200, 250
TKF	TSK	--	250, 315
TM	TSM	TSMS	355, 400
TTM	TST	TSTS	450, 500
TTM	--	--	560, 630
--	TSL	TSLS	560
TLM	TSL	TSLS	630, 670, 710, 750, 800

## APPLICATION

### Steady-load circuits

The HBC fuselink selected should have a current rating not less than the normal full-load current of the circuit.

### Complete Cable Protection

Class 'gG' 'T' range fuselinks provide complete protection and enable cables to be fully rated in accordance with IEE wiring regulations for electrical installation (16th edition).

Both overload and short-circuit protection are provided if the current rating of the fuselink is equal to or less than, the current rating of the cable.

In some circuits, like motor applications, it is not economical to match fuselink and cable ratings to provide complete cable protection, because of the significant over-currents produced during switching. In such cases, the fuselinks are chosen to provide only short-circuit protection to the associated cables and other circuit components, the necessary over-load protection being provided by other means.

## Discrimination between Fuselinks

Positive discrimination under 'short-circuit' conditions is achieved when the larger or 'major' fuselink is unaffected by the fault current which caused the smaller or 'minor' fuselink to operate. The total operating  $I^2t$  let through by the 'minor' fuselink must therefore be less than the pre-arching  $I^2t$  of the 'major' fuselinks.

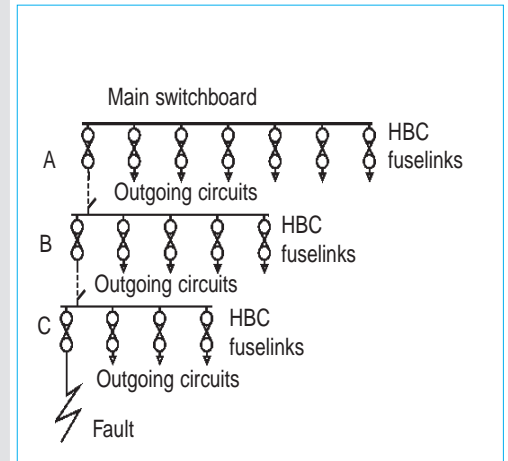

Fig. 1

Typical 3 phase (shown single line) distribution system. With properly selected G E Power Controls HBC fuselinks 'minor' fuselink 'C' operates and 'major' fuselinks 'A' & 'B' remain unaffected



## Ambient Air Temperatures

IS 13703-1993/ IEC 269-1986 on HBC fuselinks requires the fuselinks to be suitable for use in ambient air temperatures not exceeding 40°C and recognises that derating may be necessary at higher ambient temperatures.

HBC fuselinks in ratings up to 63Amp. can be used at full rating in ambient temperatures up to 60°C (in most cases even higher) and ratings 63Amp. to 160Amp. can be used in full rating in ambient temperatures up to 50°C.

The table 1 gives the derating of fuselinks at higher ambients.

These assume that the temperature inside the fuse enclosure is not more than 15°C above ambient air temperature. If the difference between enclosure temperature and ambient temperature exceeds 15°C, the enclosure temperature should be used to assess derating. To obtain comparative enclosure temperature add 15°C to the figures in Table 1.

This table applies only for continuous loads. Where fuse ratings are chosen in motor, capacitor and transformer applications, additional deration is necessary in most cases.

**Table 1 : Rating**

Nominal rating (Amp.)	at these Ambient Air Temperature (°C)				
	45°	50°	55°	60°	65°
2	2	2	2	2	2
4	4	4	4	4	4
6	6	6	6	6	6
10	10	10	10	10	10
16	16	16	16	16	16
20	20	20	20	20	20
25	25	25	25	25	25
32	32	32	32	32	32
36	36	36	36	36	30
50	50	50	50	50	45
63	63	63	63	63	55
80	80	80	75	70	65
100	100	100	95	90	80
125	125	125	120	110	105
160	160	160	145	135	125
200	200	190	180	170	160
250	250	235	225	210	200
315	300	285	270	255	240
355	350	330	315	295	280
400	400	380	360	340	320
450	425	405	380	360	335
500	450	425	400	380	375
560	520	495	465	440	410
630	570	540	510	480	450
670	615	585	550	520	490
710	665	630	595	560	525
750	710	670	630	590	550
800	720	680	640	600	560

## Capacitor Circuits

HBC fuselinks are widely used to protect against rupture of the capacitor case and to protect cables and associated equipment from damage in the event of capacitor failure.

The fuselink selected must be capable of withstanding a normal full-load current higher than that calculated from the kVA rating (because of circuit harmonics) as well as the high transient current which occurs at 'switch on'.

It has been proved in practice that these requirements are catered for by selecting a fuselink with a current rating not less than 1.5 times the rated capacitor current.

These recommendations refer to three-phase power factor correction capacitors.



## Selecting GE Power Controls HBC fuselinks for the protection of 3-Phase Induction Motors

The recommended rating of GE Power Controls HBC fuselink for a given motor starting duty can be readily obtained by the application of the data set out in Table 2, as illustrated in the example and should be adjusted to suit the starting conditions as indicated below.

### Motor starting conditions

Suitable adjustments to the recommended ratings should be made to allow for the following special conditions which may occur either singly or in combination.

- Starting currents in excess of the assumed ones.
- A large no. of starts in rapid succession. The recommendation below allows for 2 starts in rapid succession and upto 8 starts per hour.
- Ambient temperatures in excess of 40°C
- Long run-up time due to high inertia loads.

Any additional information and assistance which may be required regarding the application will be made available on receipt of the relevant details regarding circuit and operating conditions.

### Example

To find the correct fuselink for a 20 H.P. 415 Volt 3 phase induction motor with direct-on-line (DOL) starting:

- full load current 28 Amp.
- In Table 2 under the heading 'Direct-on-line start,' against the full load current of 28Amp, the fuselink rating is 63 Amp.

**Table 2 :**  
**Recommended ratings of Fuselinks for the protection of 3-Phase Induction Motors**

D O L Start			Star - Delta Start		
Motor FLC Amp		Recommended fuselink Type 'gG' Amp	Motor FLC Amp		Recommended fuselink Type 'gG' Amp
From	To	Amp	From	To	Amp
0.0	0.7	2	0	1.4	2
0.8	1.4	4	1.5	2.1	4
1.5	2.0	6	2.2	3.1	6
2.1	3.0	10	3.2	5.5	10
3.1	6.1	16	5.6	10	16
6.2	9.0	20	10.1	14	20
9.1	11.0	25	14.1	18	25
11.1	14.4	32	18.1	22	32
14.5	15.4	36	22.1	28	36
15.5	18.0	40	28.1	32	40
18.1	22.0	50	32.1	40	50
22.1	28.0	63	40.1	51	63
28.1	45	80	51.1	80	80
45.1	58	100	80.1	100	100
58.1	80	125	100.1	125	125
80.1	99	160	125.1	160	160
99.1	128	200	160.1	200	200
128.1	180	250	200.1	250	250
180.1	216	315	250.1	315	315
216.1	270	355	315.1	355	355
270.1	328	400	355.1	400	400
328.1	385	450	400.1	450	450
385.1	430	500	450.1	500	500
430.1	500	560	500.1	560	560
500.1	560	630	560.1	630	630
560.1	620	670			

Above table is based on the following motor starting performance data

Motor Rating	Direct-on-line starting conditions	Assisted start conditions
Upto 1 kW	5 x FLC for 5 secs	2.5 x FLC for 20 secs
1.1 to 7.5 kW	6 x FLC for 10 secs	3.5 x FLC for 20 secs
7.6 to 75 kW	7 x FLC for 10 secs	
> 75kW	6 x FLC for 15 secs	

### Warning

- Do not use wires as replacement for blown HBC fuselinks. Arcing takes place inside HBC fuse cartridge during fault and hence your installation is safe. Bare wire will vapourise and bridge the contacts inside the equipments. This may cause explosion and danger to personnel.
- Buy fuselinks only from Authorised Dealers of GE Power Controls India (list available at our offices) to avoid purchase of spurious and rewired fuselinks.
- Do not auction blown HBC fuselinks as these are the raw materials for spurious fuselinks. Break the blown HBC fuselinks and sell the caps, tags and elements as scrap.



## Overall dimensions

Staggered tag - SS / NS / ES

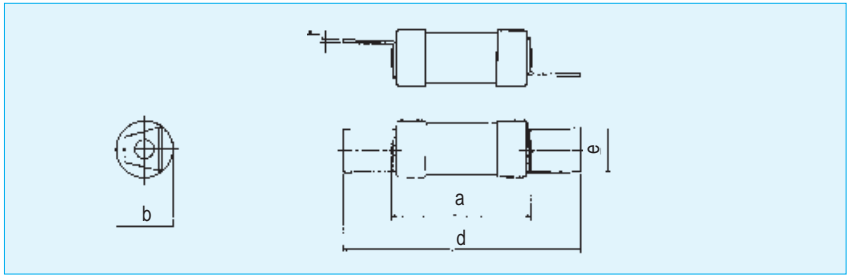

Offset tag - EIT/TSS

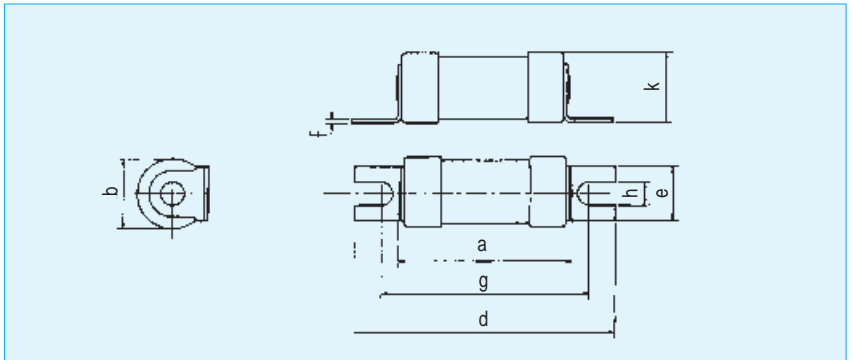

Offset tag - TSA / TIA / TIS / TCP / TSD / TSDS / TFP / TSFP

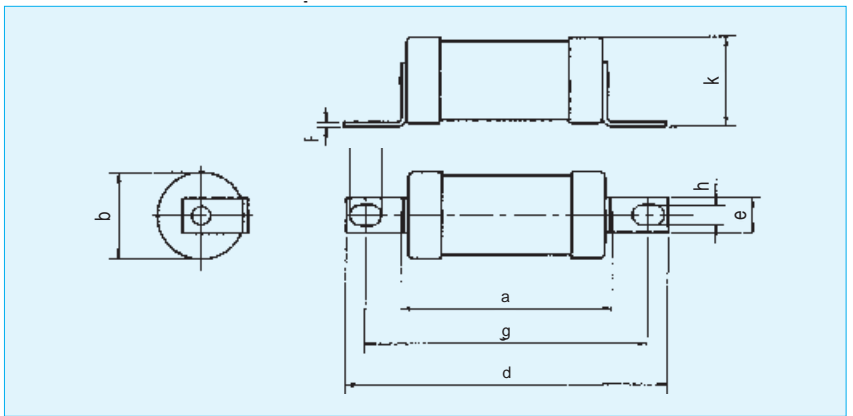

### Dimensions (in mm)

Type	a	b	d	e	f	g	h	j	k
SS	24.4	14.1	50.0	11.0	0.8	--	--	--	--
NS	35.0	14.1	60.3	11.0	0.8	--	--	--	--
ES	36.0	17.3	66.0	15.0	1.2	--	--	--	--
EIT(2-32A)	36.3	14.1	65.5	11.0	1.2	55.0	5.5	--	15.0
EIT(36-63A)	36.3	17.3	65.5	11.0	1.2	55.0	5.5	--	18.2
TSA	35.0	14.1	83.0	8.9	1.2	73.0	5.0	8.0	15.2
TIA	55.0	22.5	83.9	8.9	1.2	73.0	5.2	8.2	23.5
TSS	38.8	17.3	83.9	8.9	1.2	73.0	5.2	--	18.5
TIS	55.0	22.5	83.9	8.9	1.2	73.0	5.2	8.2	23.5
TCP	59.0	26.4	111.0	19.1	2.4	94.0	8.8	11.9	28.0
TSD	56.0	22.5	109.0	19.0	2.4	94.0	9.0	12.0	25.0
TSDS	56.0	22.5	89.5	19.0	2.4	73.0	6.0	7.0	25.0
TFP	74.4	40.0	109.8	19.1	2.4	94.0	7.1	10.4	40.7
TSFP	57.0	33.7	112.0	19.0	2.4	94.0	9.0	12.0	34.3



Central tag 2 hole fixing

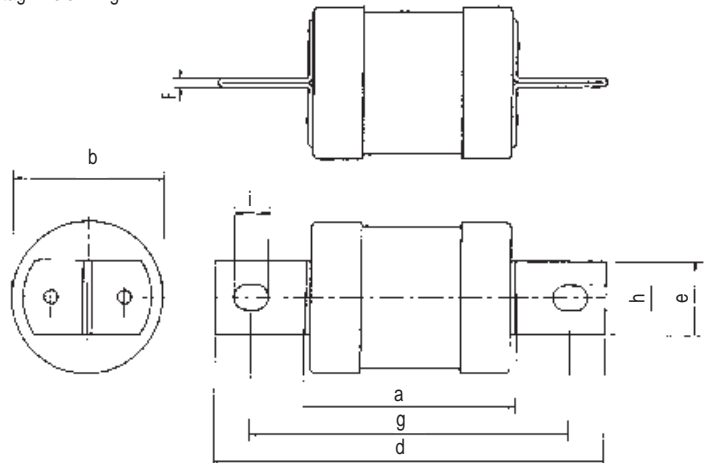

Dimensions (in mm)

Type	a	b	d	e	f	g	h	j
TC	58.0	26.4	133.9	19.1	3.2	111.0	8.8	11.9
TSDC	54.5	22.5	137.0	19.0	3.2	111.0	9.0	12.0
TF	75.3	40.0	135.0	19.1	3.2	111.0	8.8	11.9
TSF	55.5	33.7	131.0	19.0	3.2	111.0	9.0	12.0
TKF	74.0	52.6	136.0	25.4	3.2	111.0	8.8	11.9
TSK	55.5	40.0	131.0	25.4	3.2	111.0	9.0	12.0
TSMS	57.5	52.5	162.5	25.4	5.0	133.0	11.0	16.0
TSTS	58.5	60.0	162.5	25.4	6.3	133.0	11.0	16.0
TSL	62.5	74.2	162.5	25.4	10.0	133.0	11.0	16.0

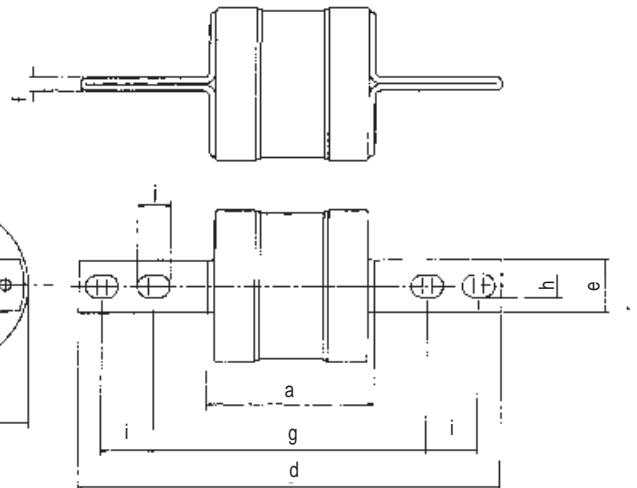

Dimensions (in mm)

Type	a	b	d	e	f	g	h	j	k	l
TM	81.0	60.2	208.5	25.4	5.0	133.0	11.1	15.9	--	25.4
TSM	57.5	52.5	212.5	25.4	5.0	133.0	11.0	16.0	--	25.4
TTM	82.3	74.4	208.5	25.4	6.3	133.0	11.1	15.9	--	25.4
TST	58.5	60.0	212.5	25.4	6.3	133.0	11.0	16.0	--	25.4
TLM	87.5	82.2	208.5	25.4	9.8	133.0	11.1	15.9	--	25.4
TSL	62.5	74.2	212.5	25.4	10.0	133.0	11.0	16.0	--	25.4



**Fuselink Selection Chart**

Type ref. & current range		CURRENT RATING		
		T	TS	
Fuse fittings	NS/SM	NSH		
		SM32		
		SM63		
	Safe Clip	SM125		
		SC20		
		SC32		
	Independent mounted switch	LP	SC63	
			LP32	
		WM	LP63	
			WM20	
			WM32	
		CH	WM63	
CH63				
CH100				
CH200				
CHD		CH315		
		CHD400		
		CHD500		
	CHD630			
Cubicle mounted switch	SP with BS fuses	CHD800		
		SP1.5		
		SP02		
		SP32-EIT		
		SP63-EIT		
		SP32-NS		
		SP63-ES		
		SPO3		
	CMM with BS fuses	SPO5		
		SPO7		
		CMM125		
		CMM200		
	CMM250			
	CMM315			
	CMM400			
	CMM630			
	CMM800			

**Caution : Do not use Fuselinks having current rating higher than the rating of the equipment.**





## Type SS fuselinks

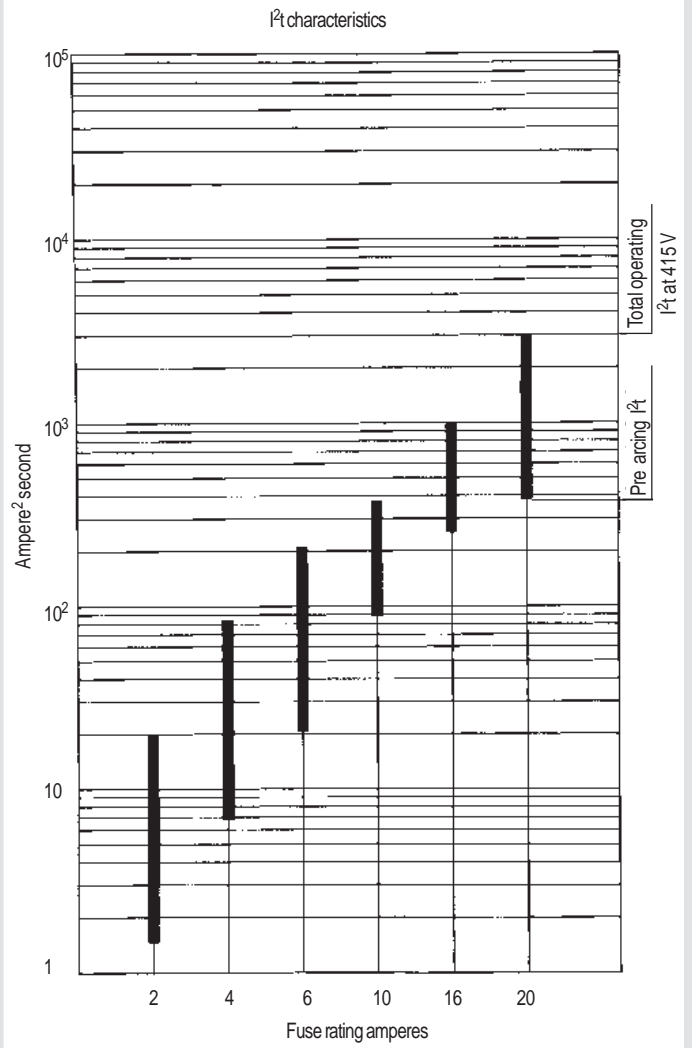
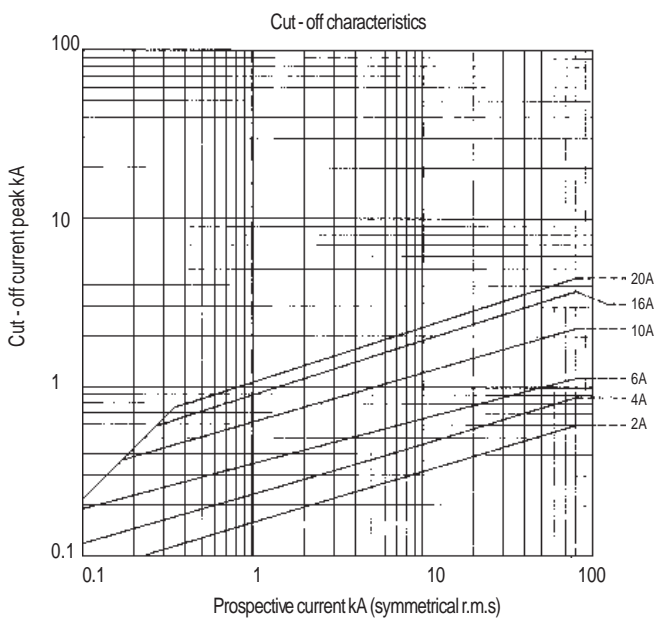
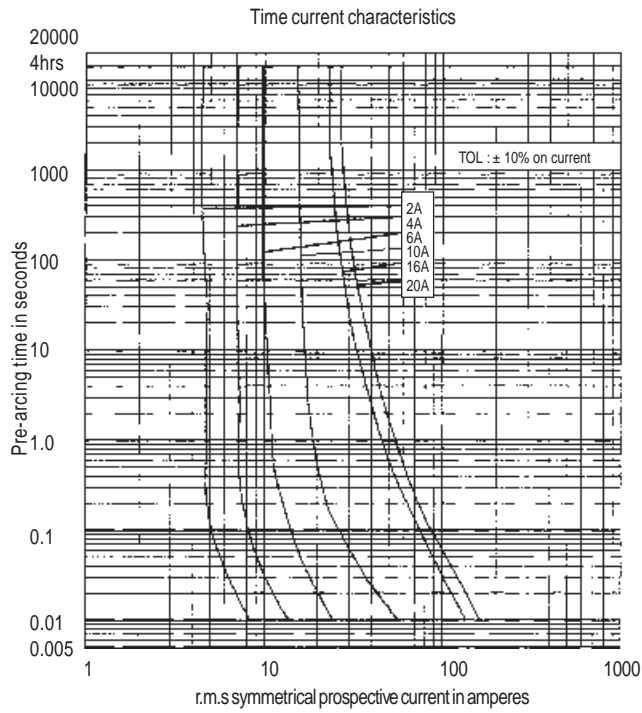



## Type NS / ES / EIT fuselinks

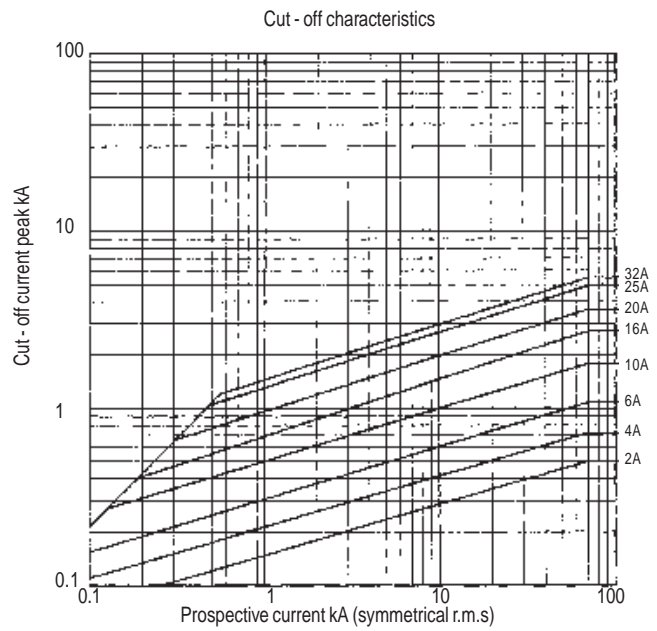
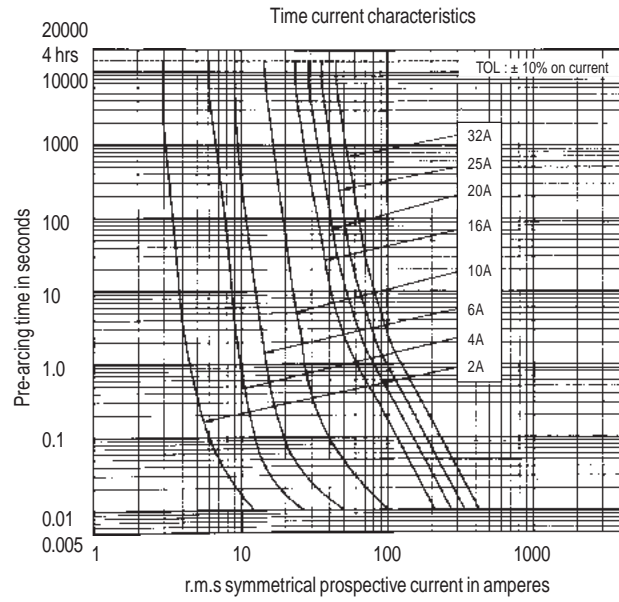



## Type ES / EIT fuselinks

Time current characteristics

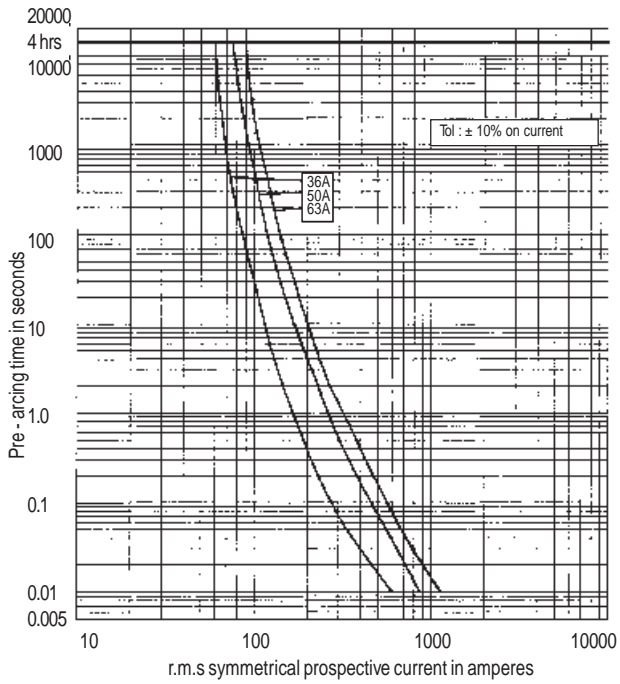

Cut-off characteristics

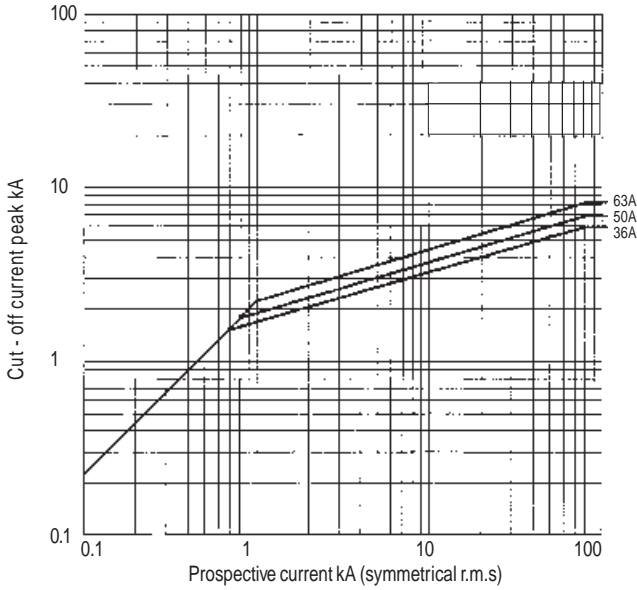

$I^2t$  characteristics

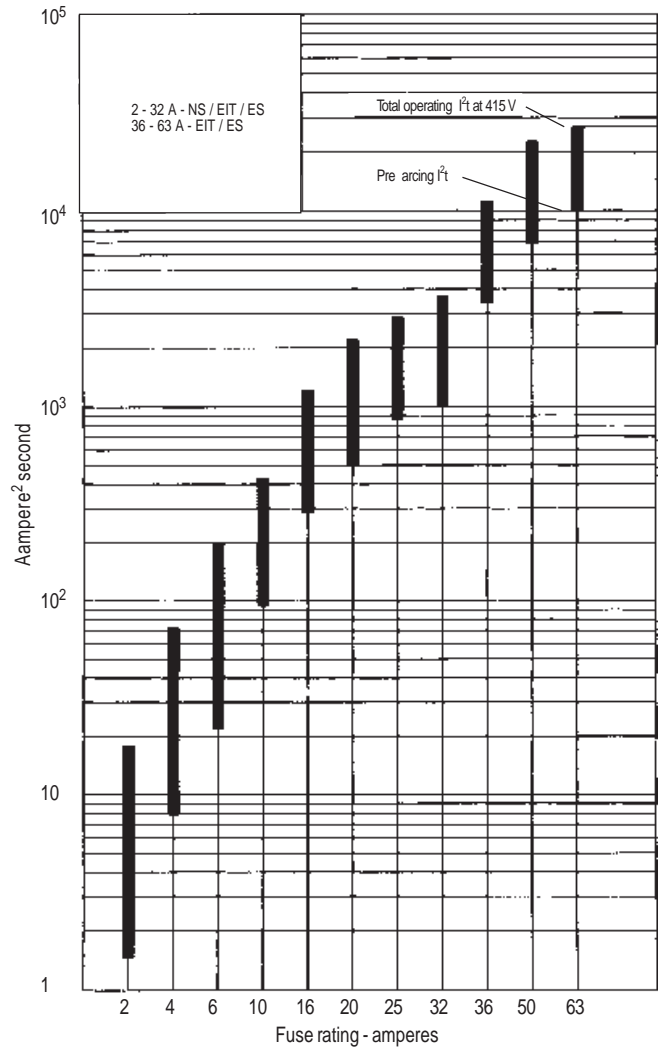



## Type T fuselinks

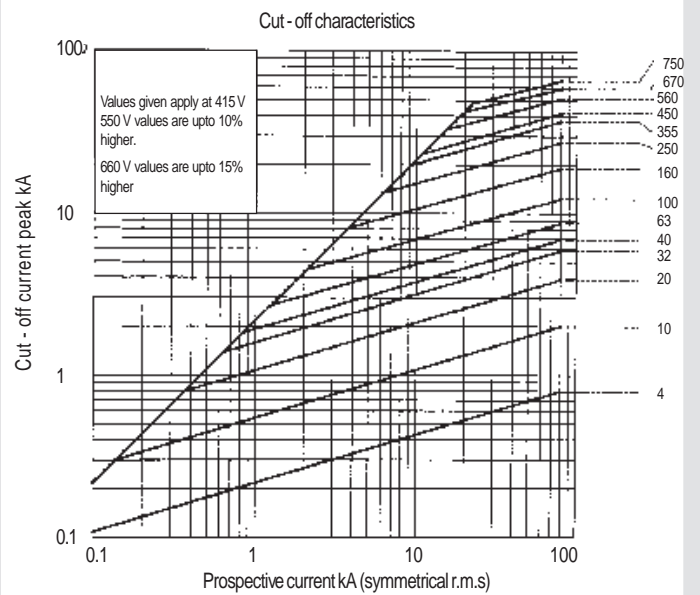
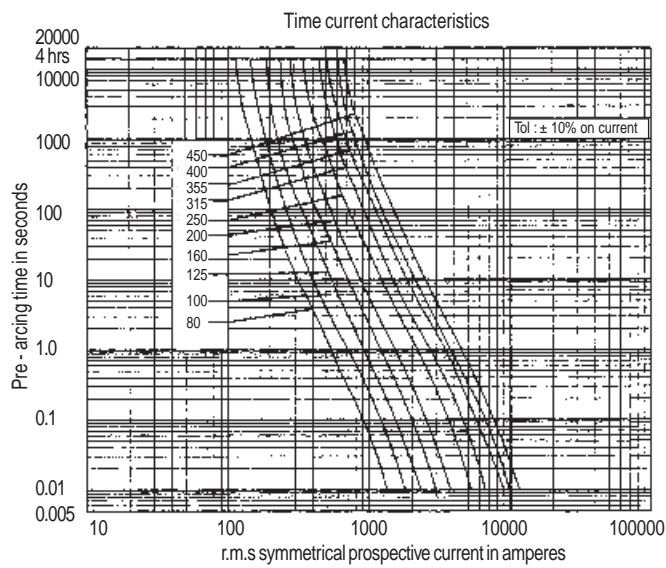
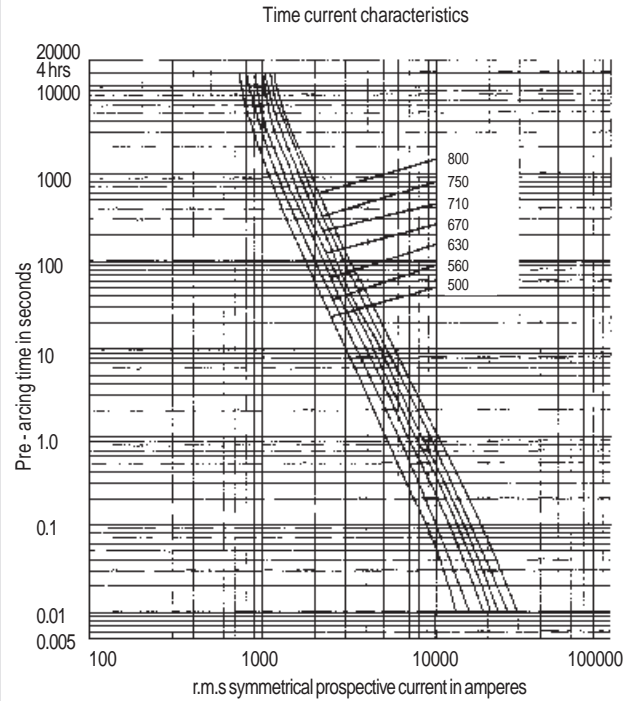
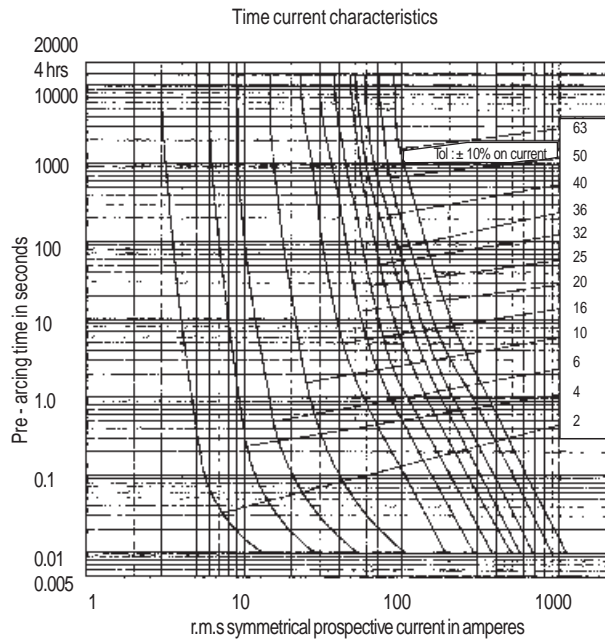



## Type T fuselinks

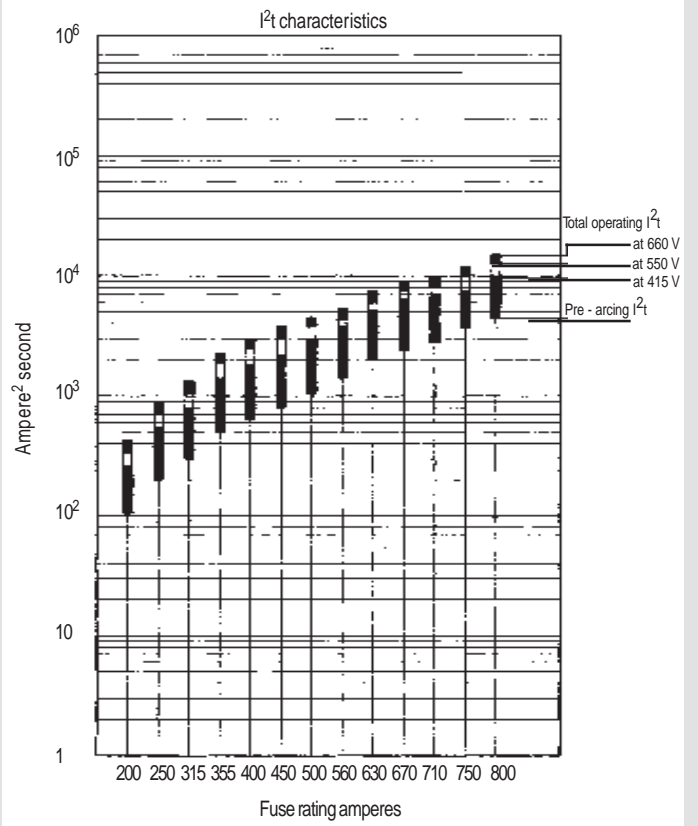
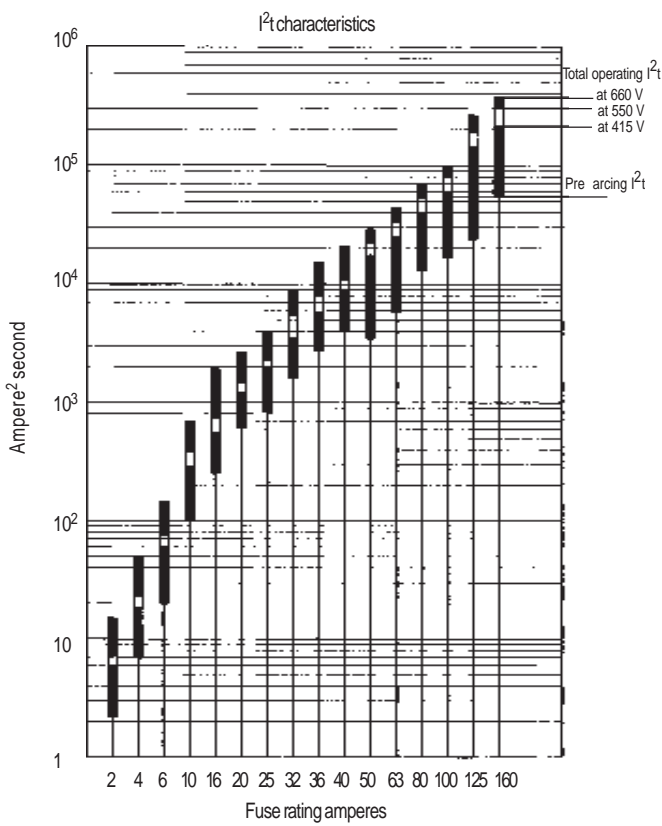
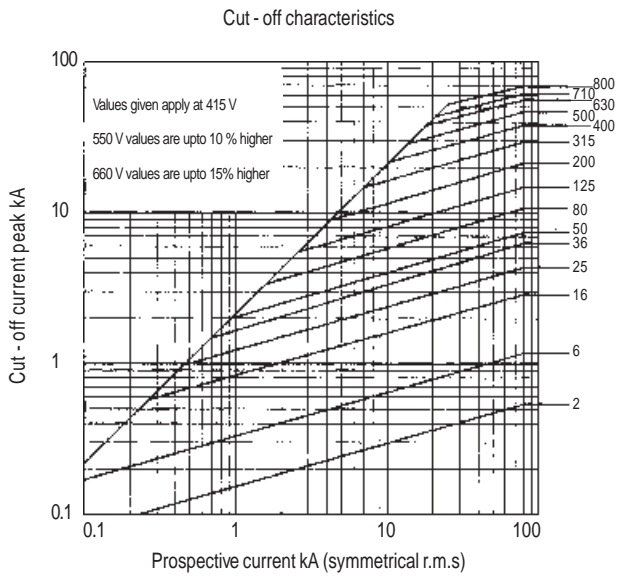



## Type TS fuselinks

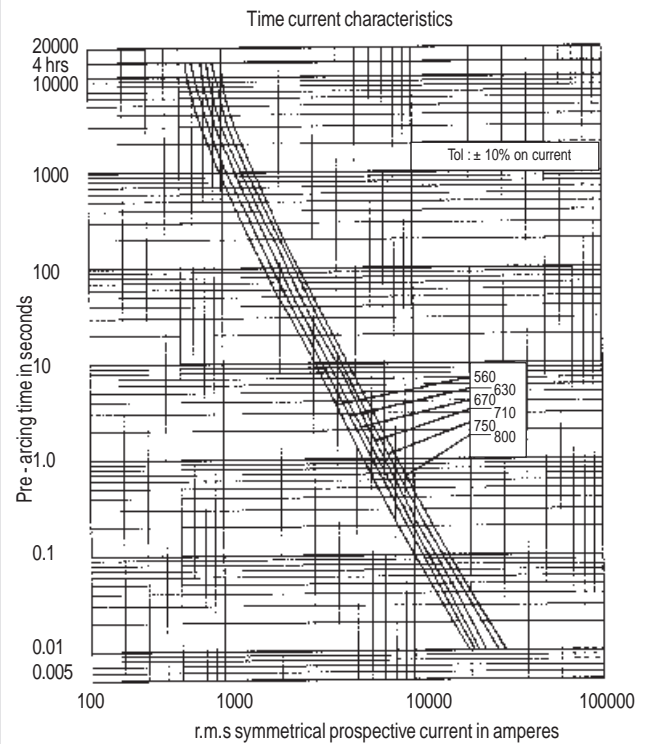
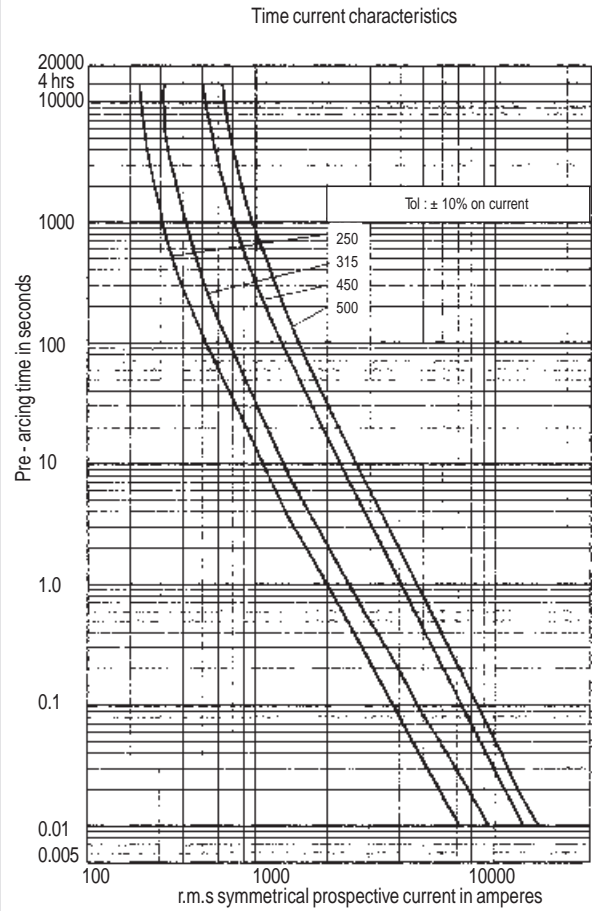
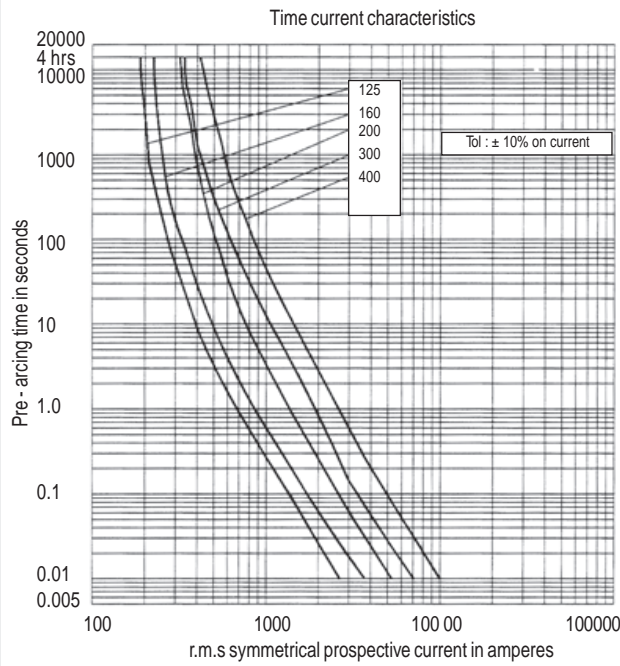
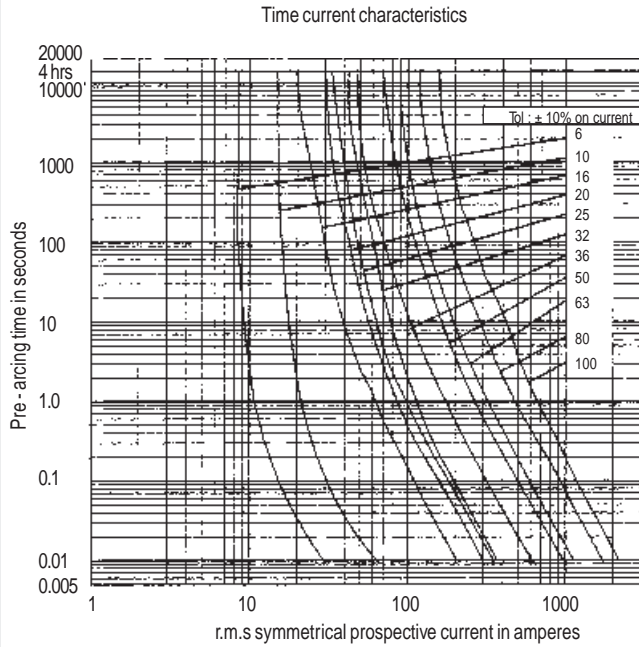



## Type TS fuselinks

Cut - off characteristics

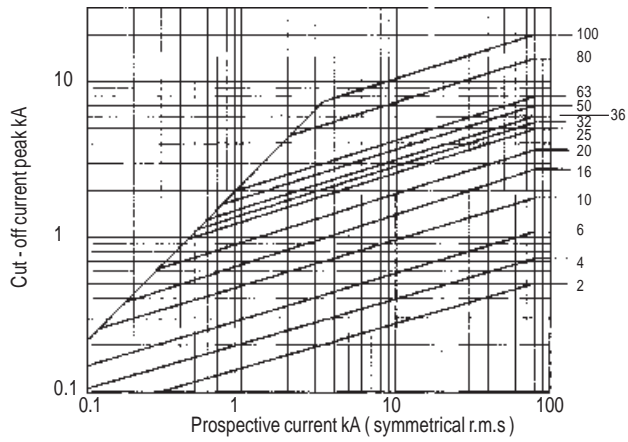

Cut - off characteristics

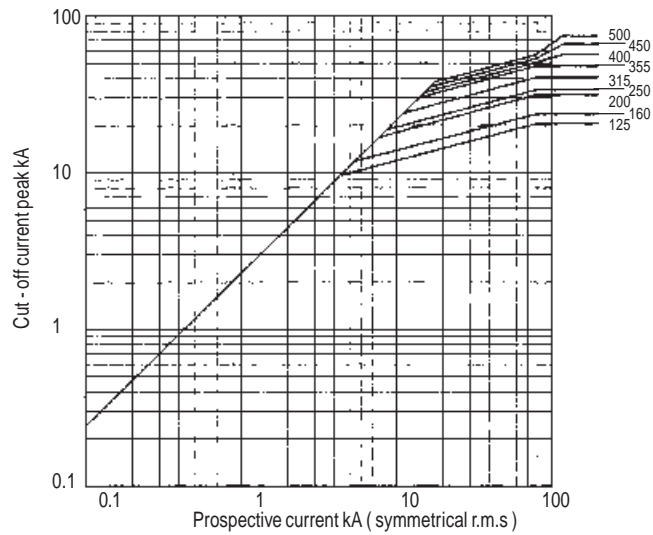

Cut - off characteristics

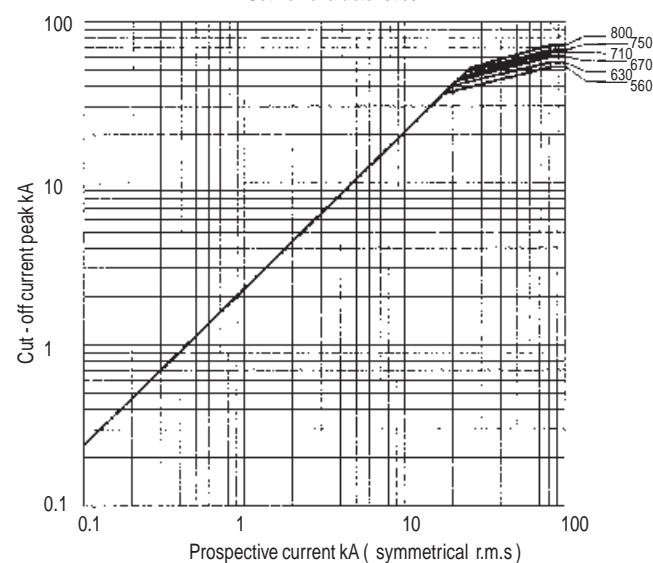

$I^2t$  characteristics

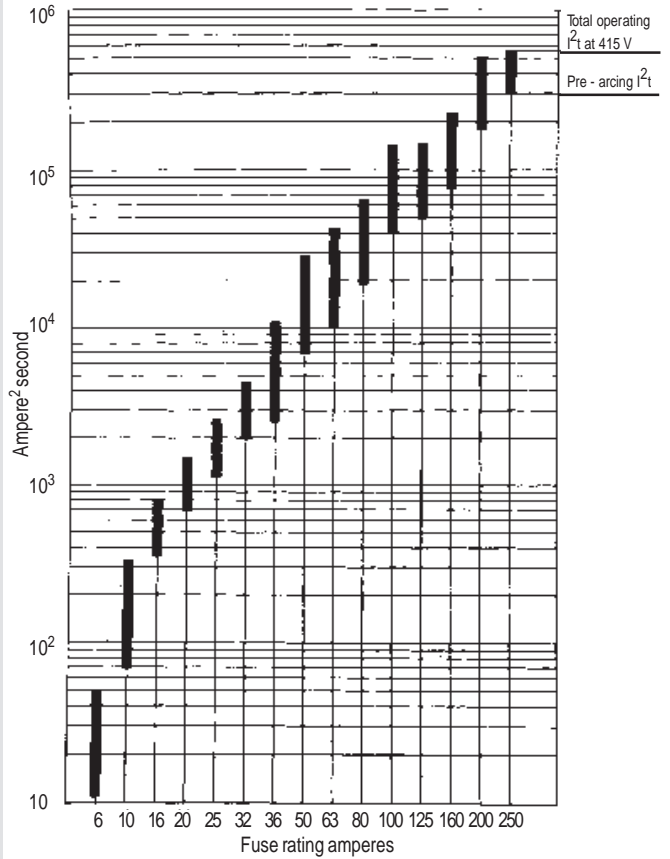

$I^2t$  characteristics

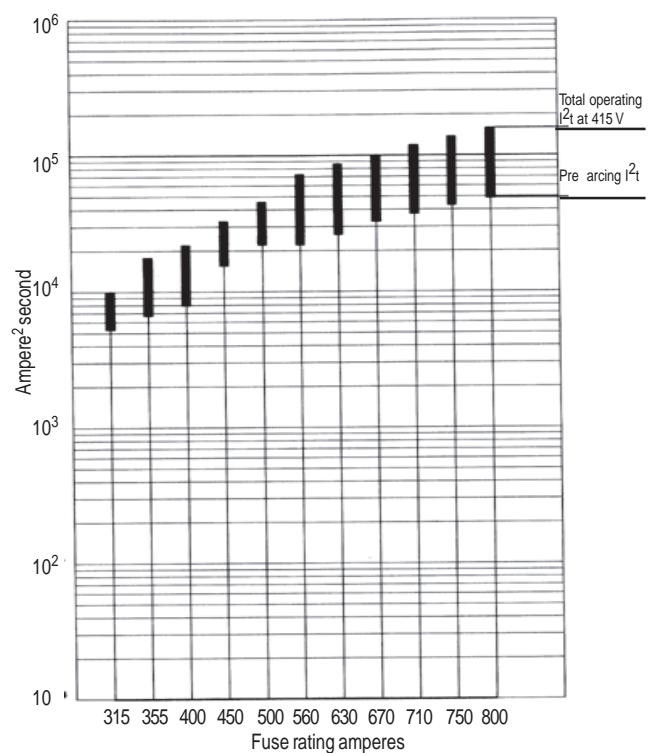





GE Power Controls type VS HBC (High Breaking Capacity) fuselinks with blade contacts offer precise and perfect protection to low voltage circuits for industrial and general applications.

- 6 amps to 630 amps in five sizes with breaking capacity of 80kA at 500 V ac
- Strict compliance to performance and dimensional requirements of Indian and international standards: IS 13703/IEC 269
- Close excess current protection with characteristic type gG
- Superior overload performance for motor and capacitor circuits involving surge currents
- Very low power loss ensures cool running
- Extremely low let through  $I^2t$  and cut off currents at short circuits
- Positive indication of fuse operation by flag indicator
- Fully tested and certified at CPRI for 500 V ac (at 550V recovery voltage)
- ISI certified to IS 13703 - 1993

**Range :**

Size	Type	Current Rating in Amps	ISG Fusebase List Number
000	VSA	6,10,16,20,25,32,36,50,63	ISG 160
00	VSB	6, 8, 10, 16, 20, 25, 32,36, 50, 63, 80, 100, 125, 160	ISG 160
1	VSF	36, 50, 63, 80, 100, 125,160, 200, 250	ISG 250
2	VSK	250, 315, 355, 400	ISG 400
3	VST	315, 355, 400, 500, 630	ISG 630

\* Rated Voltage for ISG Fusebase 660V

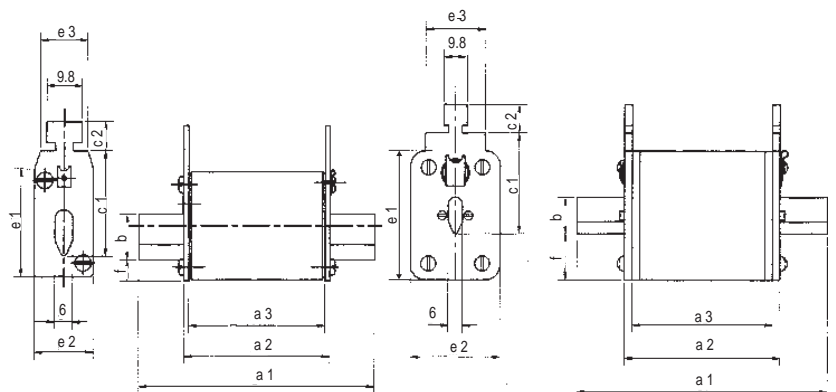

Size	Type	a <sub>1</sub>	a <sub>2</sub>	a <sub>3</sub>	b	c <sub>1</sub>	c <sub>2</sub>	e <sub>1</sub>	e <sub>2</sub>	e <sub>3</sub>	f
000	VSA	79.0	49.0	44.0	15.3	35.1	9.7	36.0	21.0	16.0	6.0
00	VSB	79.0	49.2	45.2	15.0	35.0	9.5	43.0	30.0	20.0	14.0
1	VSF	135.0	66.6	61.6	23.0	39.9	10.0	51.0	51.0	22.0	14.6
2	VSK	150.0	66.6	61.6	30.0	48.2	10.0	57.0	56.0	22.0	13.3
3	VST	150.0	66.6	61.6	34.0	59.7	9.5	72.0	72.0	22.0	17.8

Dimensional tolerances are as per data sheet in mm 11 of IS 13703/IEC 269

Type 'ISG' fuse base is available for VS HBC fuselinks - single pole bases ( 160 A to 630 A ) and three pole base ( 160 A ).





## Type VSA (Size 000) fuselinks

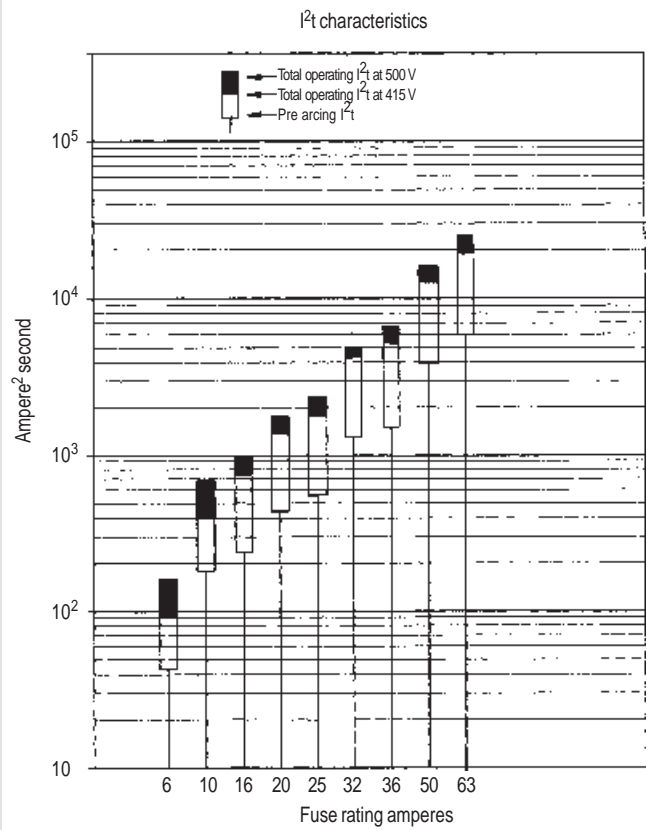
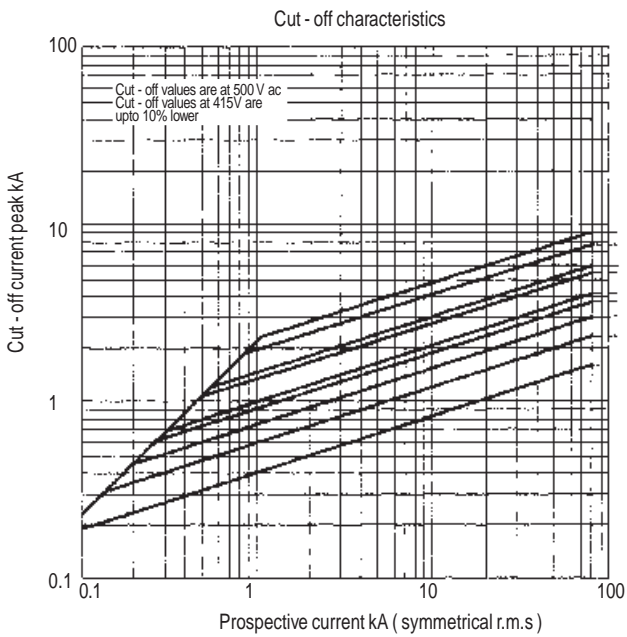
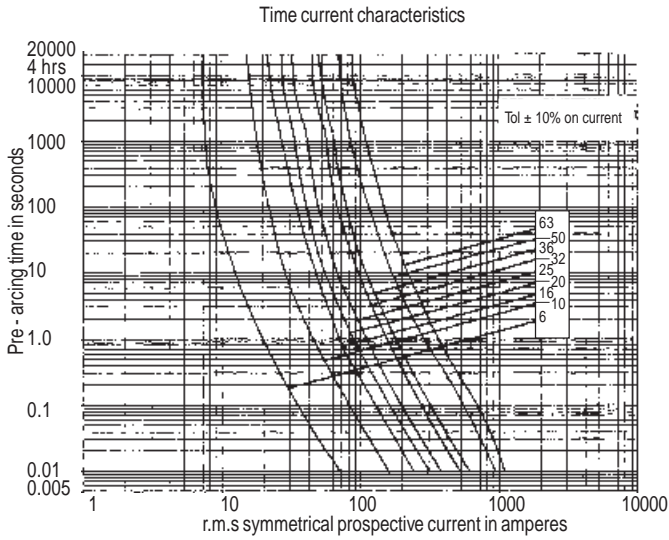



## Type VSB (Size 00) fuselinks

Time current characteristics

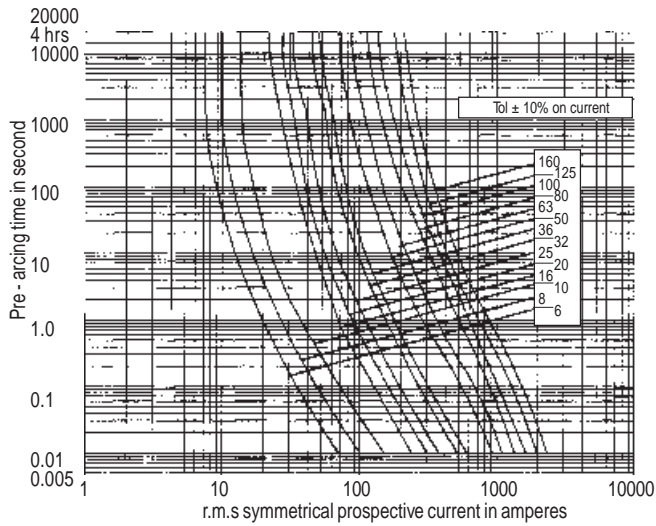

Cut - off characteristics

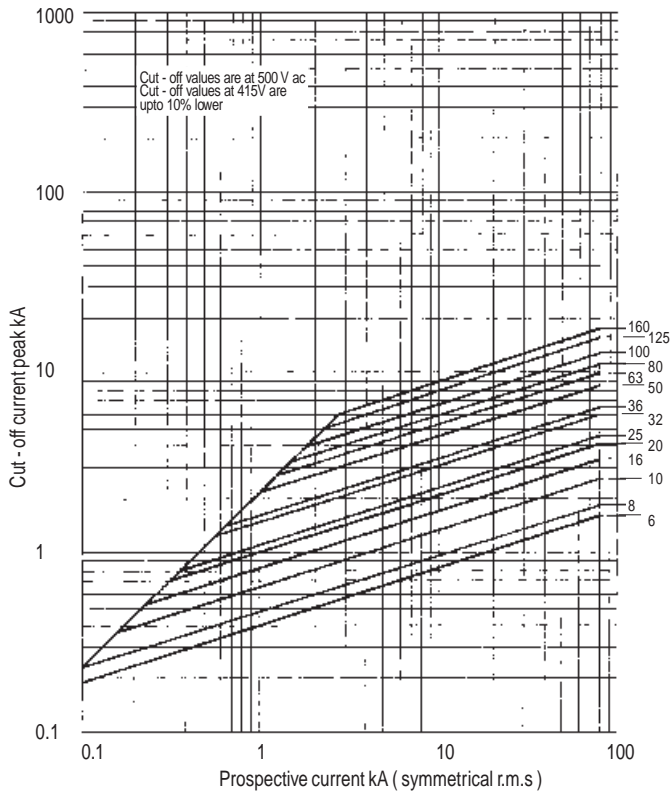

$I^2t$  characteristics

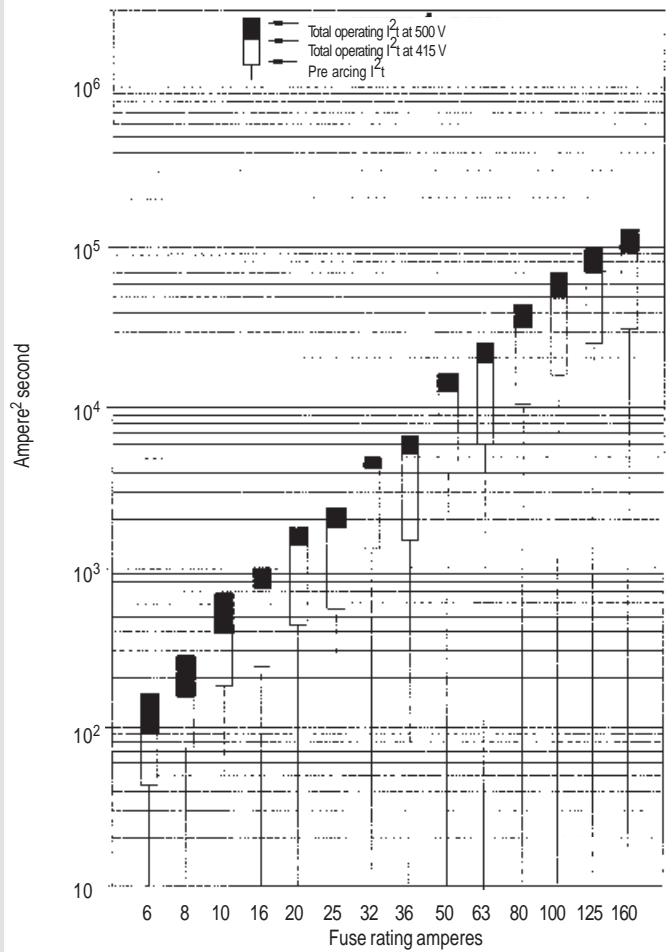



## Type VSF (Size 1) fuselinks

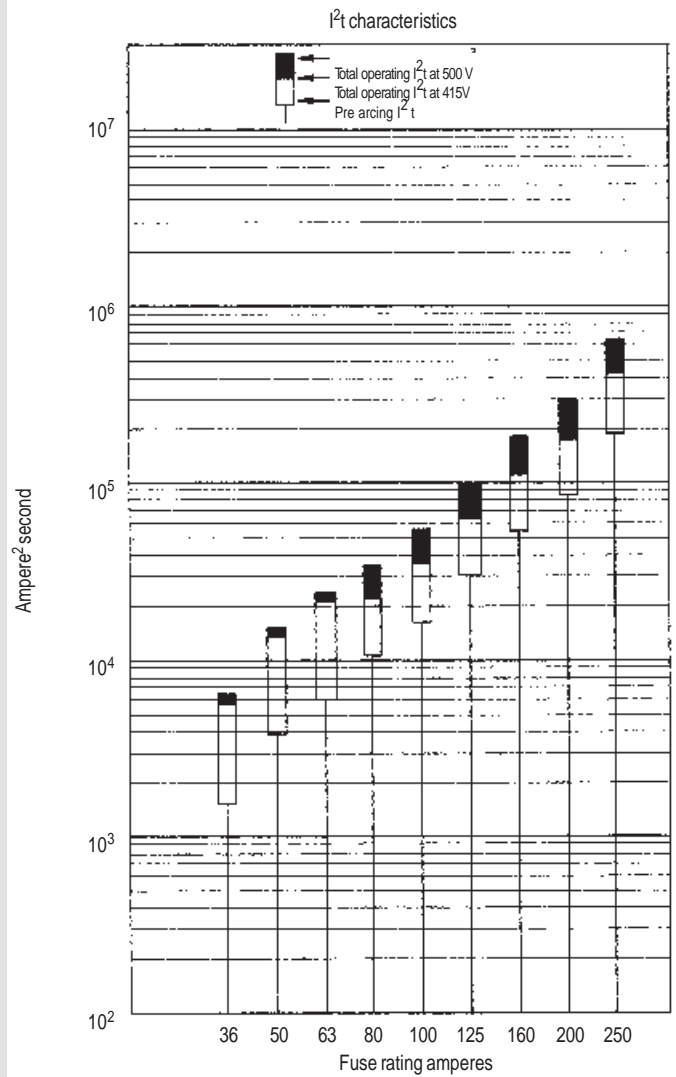
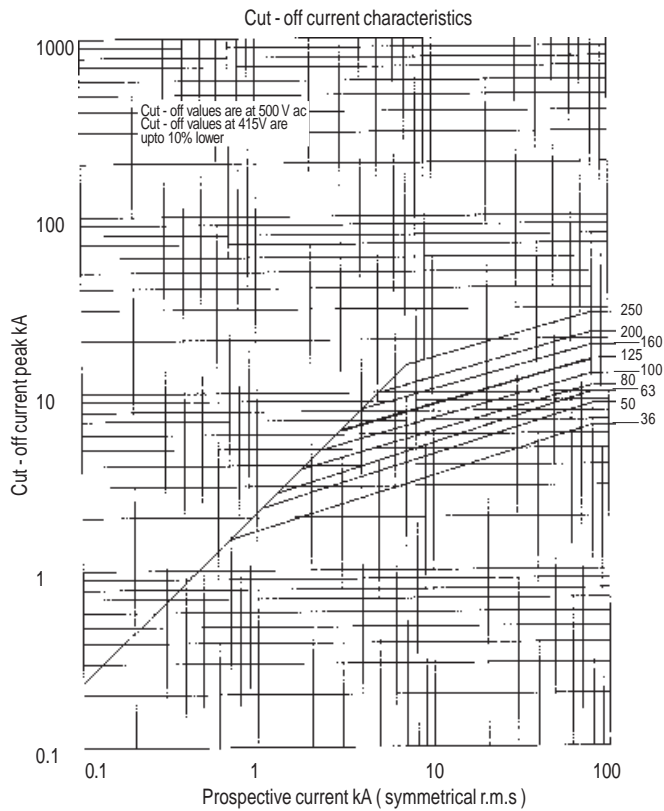
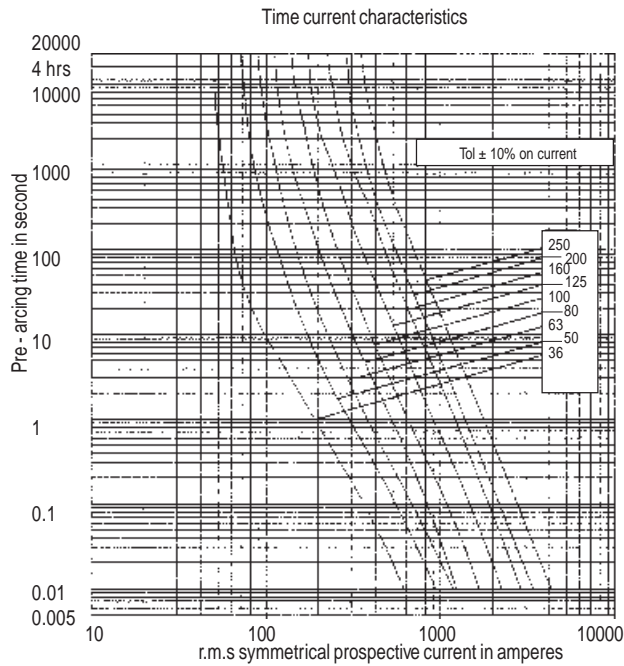



## Type VSK (Size 2) fuselinks

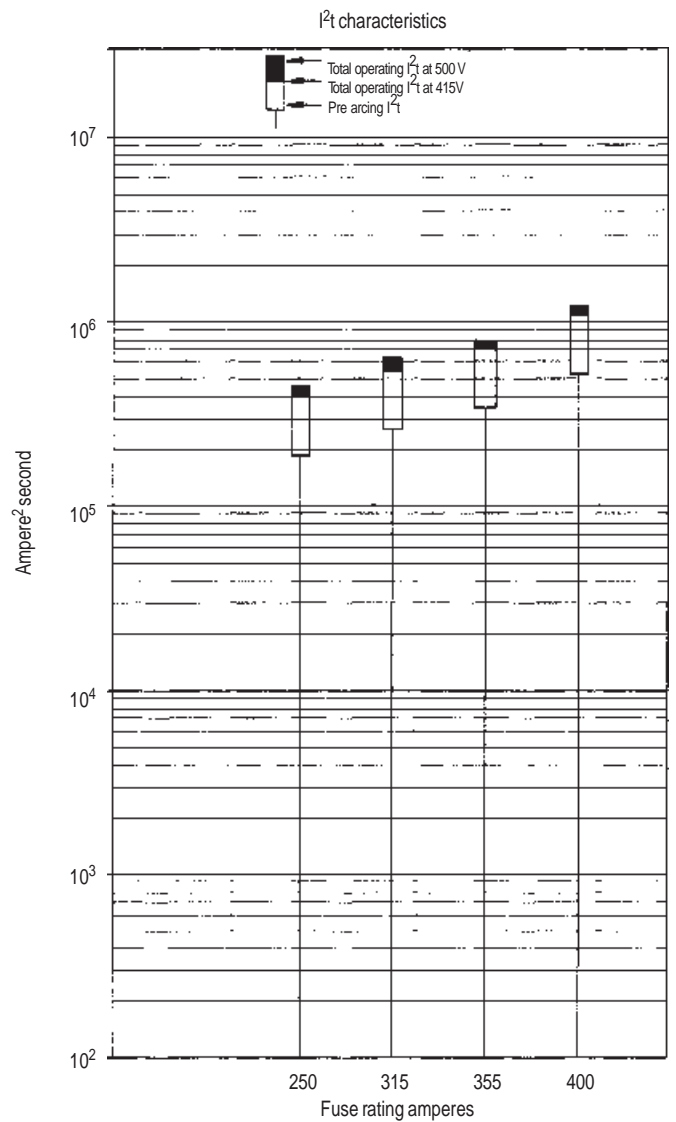
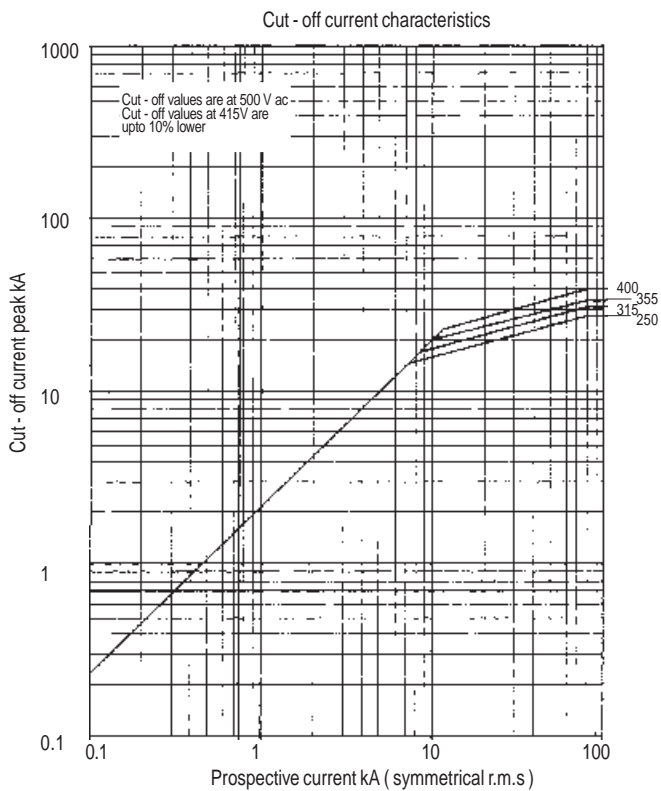
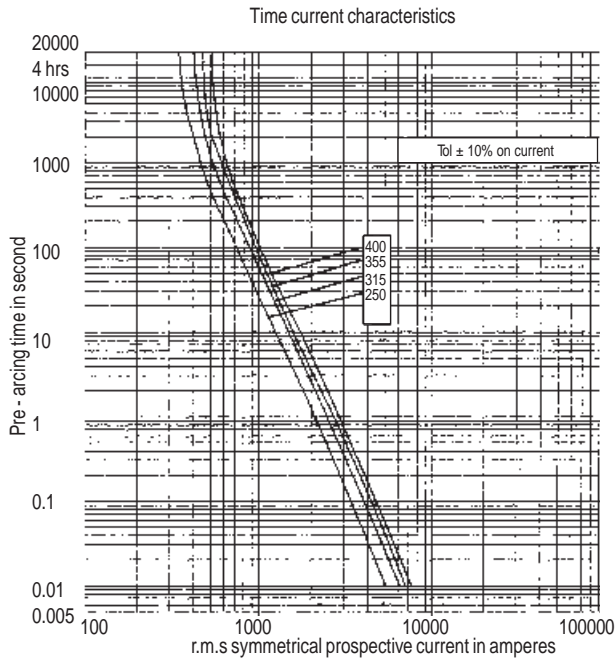



## Type VST (Size 3) fuselinks

